

PRELIMINARY DRAWING – NOT
SUITABLE FOR CONSTRUCTION
DO NOT SCALE IF IN DOUBT ASK!

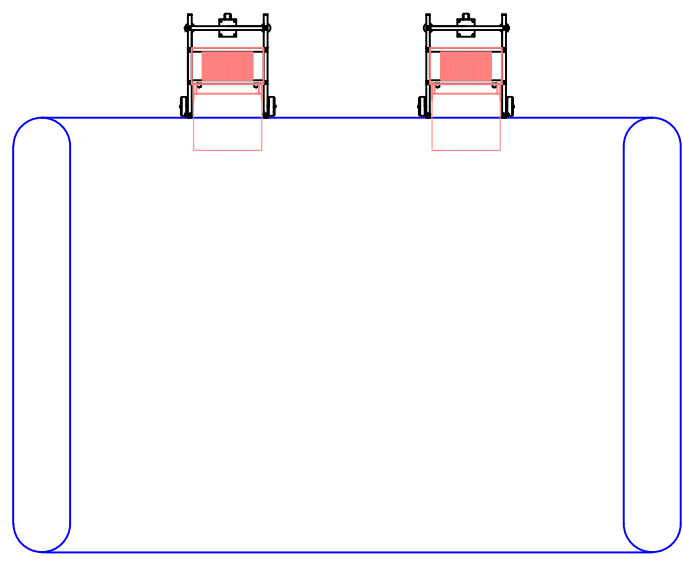

PLAN VIEW

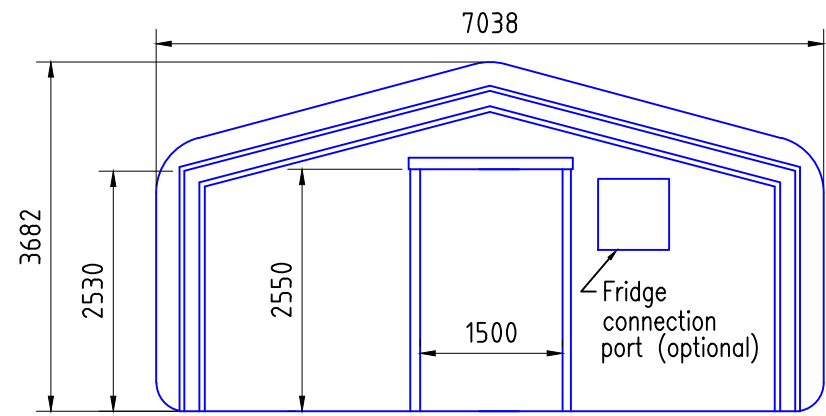
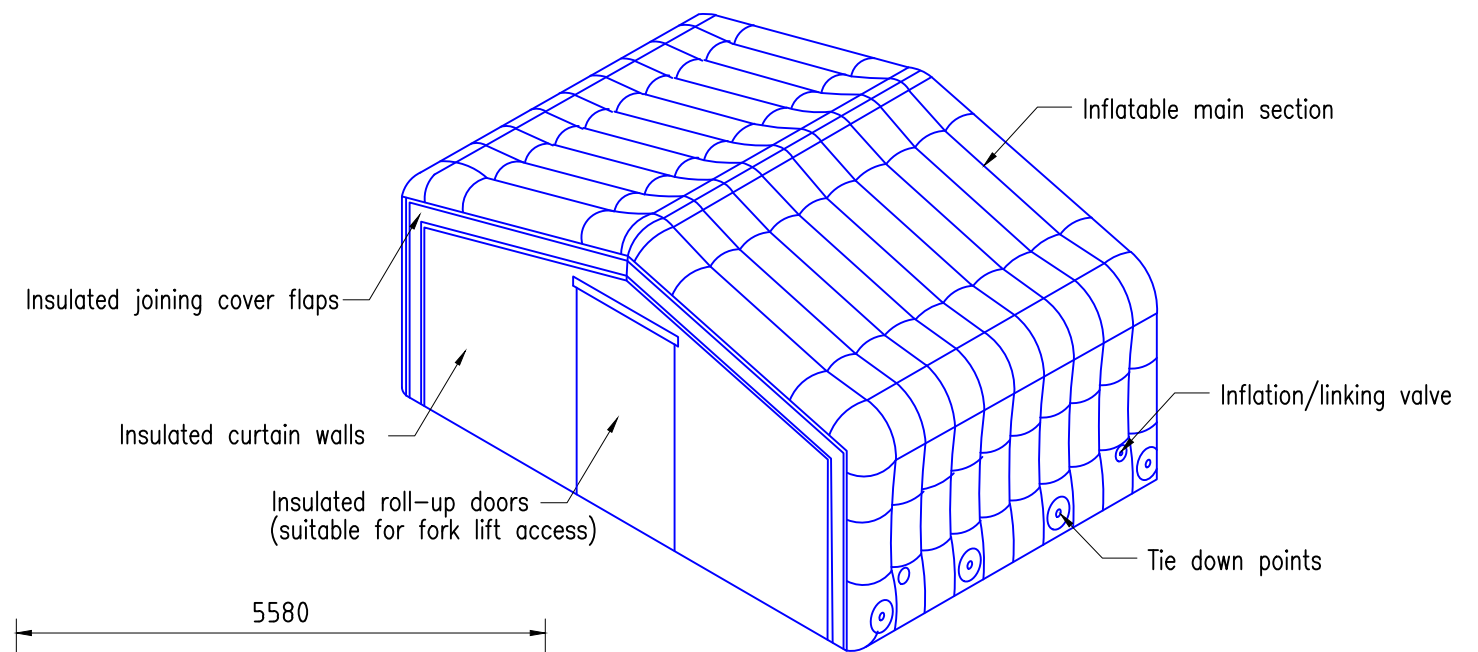

DOOR ELEVATION

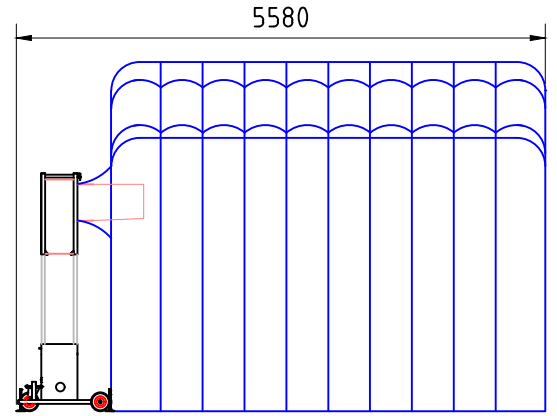

SIDE ELEVATION

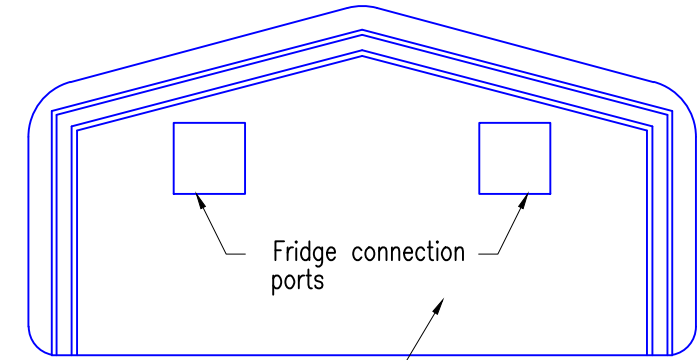

FRIDGE ELEVATION

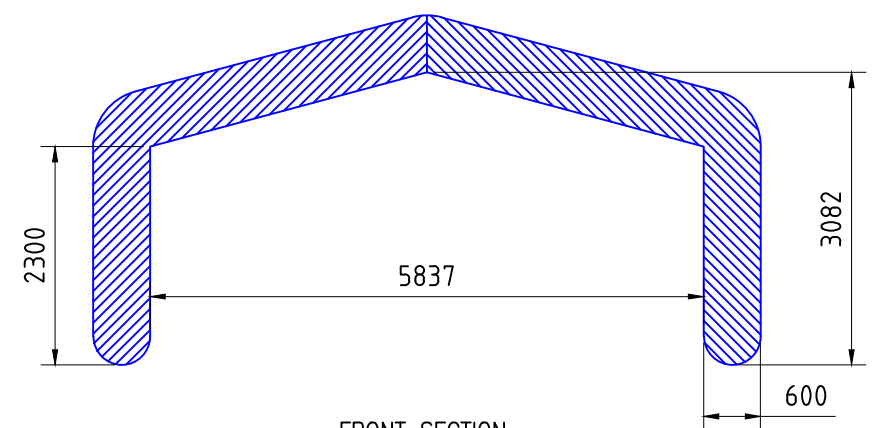

FRONT SECTION

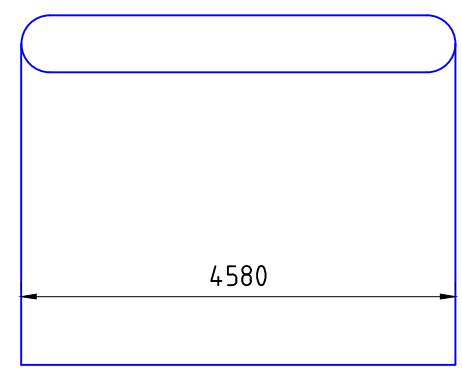

SIDE SECTION

INTERNAL VOLUME:
72 CUBIC METRES

©Dawsongroup temperature control solution
All rights reserved. No part of this design
may be used or reproduced without the
written permission of Dawsongroup
temperature control solution limited.

Dawsongroup | temperature control solutions

DATES:	
CREATED:	09/01/2020 12:58 PM
UPDATED:	13/04/2021 4:37 PM
PRINTED:	13/04/2021 4:43 PM



Dawsongroup | temperature control solutions
● Fulwood Industrial Estate, Export Drive,
Sutton In Ashfield, Nottinghamshire NG17 6AF
tel : (01623) 516666
web site : www.dgtcs.co.uk

DIMS. IN mm
PRINT SIZE: A3
SCALE: NTS
DRAWN: LG

PROJECT: TEMPSTORE 26
DRAWING TITLE: ALL VIEWS
DRAWING NUMBER: TempStore 26